

Grove TMS9000E

Product Guide



Features

- 90 t (110 USt) capacity
- 11,2 m - 43,3 m (36 ft - 142 ft) five-section full power boom
- Patented TWIN-LOCK™ boom pinning system
- 10 m - 17 m (33 ft - 56 ft) bi-fold lattice swingaway extension
- Optional lattice insert extensions for a 72,2 m (237 ft) maximum tip height
- Tilttable superstructure cab
- Up to 21 300 kg (48,500 lb) counterweight with hydraulic removal system



Features

MEGAFORM™ boom

The Grove MEGAFORM™ boom shape eliminates weight and increases capacity compared to conventional shapes. The unique TWIN-LOCK™ boom pinning system automatically pins the sections in position using two horizontal large diameter pins. A single cylinder inside the boom reduces weight which has been used elsewhere to strengthen the machine.



Counterweight

Up to 21 300 kg (48,500 lb) of counterweight can be power installed and removed from the superstructure cab, making transporting a breeze.



Crane Control system

Crane functions are controlled by ECOS (Electronic Crane Operating System) with CAN-BUS. The EKS5 load moment indicator provides detailed feedback and control of the crane's operating functions.



Outriggers

Two-stage inverted jack outriggers provide three position settings – 0%, 50% and 100%.



Power luffing extension

For improved up-and-over reach, a power luffing extension is available on the TMS9000E hydraulically offsettable from the superstructure cab from 5° to 40°.



Suspension

Standard front and rear air ride suspension provides a comfortable ride at 105 kph (65 mph).

Contents

Specifications	4
Dimensions	7
Counterweight	8
Travel proposal	9
Working range	10
Load charts	11
Working range	14
Load charts	15
Working range	17
Load charts	18
Load handling	24
Symbols glossary	25

Specifications

Superstructure

Boom

11,2 m - 43,2 m (37 ft - 142 ft) five-section, full power boom with TWIN-LOCK™ boom pinning system. Maximum tip height: 45,8 m (150 ft).

Boom nose

Five nylatron sheaves, mounted on heavy duty tapered roller bearings with removable pin-type rope guards. Quick reeve boom nose. Removable auxiliary boom nose with removable pin type rope guard.

Boom elevation

Single lift cylinder with safety valve provides boom angle from -3° to +82°.

Offsettable lattice extension

10 m - 17 m (33 ft - 56 ft) bi-fold lattice swingaway extension manual offset at 0°, 20°, and 40°. Maximum tip height: 63,1 m (207 ft).

*Optional offsettable lattice extension

10 m - 17 m (33 ft - 56 ft) bi-fold lattice swingaway extension hydraulically offset from 5° - 40°. Controlled from the crane cab. Maximum tip height: 63,1 m (207 ft).

*Lattice jib extension

Two 5 m (16 ft) inserts for use with lattice swingaway extension to increase length up to 21,9 m (72 ft) or 26,8 m (88 ft). Maximum tip height: 72,2 m (237 ft)

Load moment and anti-two block system

Load moment and anti-two block system with audio/visual warning and control lever lockout provides electronic display of boom angle, length, radius, tip height, relative load moment, maximum permissible load, load indication and warning of impending two-block condition.

Cab

All aluminum construction cab with acoustical lining is hydraulically tiltable to +20° and includes tinted safety glass, adjustable operator's seat with hydraulic suspension, sliding windows in side and cab rear, hinged front window with wiper, sun visor and window shade. Other features include diesel heater/defroster, armrest integrated crane controls, and ergonomically arranged instrumentation.

Crane control system

Full control of all crane movements using electrical control levers with automatic reset to zero. Controls are integrated with the LMI and engine management system by CAN-BUS. ECOS system with graphic display.

Swing

Two planetary gear boxes with axial piston fixed displacement motors. Infinitely variable to 1.7 rpm. Holding brake and service brake.

Counterweight

7258 kg (16,000 lb) consisting of various sections with hydraulic installation/removal system operated from the cab.

*Optional "Heavy Lift" counterweight package consisting of (2) 4636 kg (10,000 lb) sections in addition to standard, for a total of 16 329 kg (36,000 lb).

*Optional "XL" counterweight package consisting of (2) 1814 kg (4000 lb) and (2) 1021 kg (2250 lb) wing sections in addition to standard and "Heavy Lift" package, for a total of 21 300 kg (48,500 lb).

Hydraulic system

2 separate circuits, 1 axial piston variable displacement pump (load sensing) with electronic power limiting control and 1 gear pump for swing.

2 thermostatically controlled oil coolers keep oil at optimum operating temperature.

Tank capacity: 508 l (134 gal)

Specifications

Superstructure continued

Hoist

Main and auxiliary hoists are powered by axial piston motor with planetary gear and brake. “Thumb-thumper” hoist drum rotation indicator alerts operator of hoist movement.

Hoist line pull:

- 1st Layer: 10 034 kg (22,122 lb)
- 3rd Layer: 8466 kg (18,665 lb)
- 5th Layer: 7322 kg (16,142 lb)

Maximum line speed:

111 m/min (365 fpm)

Maximum permissible line pull:

- 7621 kg (15,700 lb) Casar Eurolift
- *Optional 7784 kg (17,160 lb) 35X7 Flex-x

Rope diameter: 19 mm (3/4”)

Rope length: 225 m (738 ft) Casar Eurolift
214 m (702 ft) 35X7 Flex-x

Maximum rope storage: 300 m (984 ft)

Carrier

Chassis

Triple box section, four-axle carrier, fabricated from high strength, low alloy steel with towing and tie-down lugs.

Outrigger system

Four hydraulic telescoping, two-stage, double box beam outriggers with inverted jack and integral holding valves. Quick release type outrigger floats 610 mm (24 in) diameter. Three position setting with fully extended, intermediate (50%) extended and fully retracted capacities.

Maximum outrigger pad load: 49 442 kg (109,000 lb).

Outrigger controls

Located in the superstructure cab and on either side of carrier. Crane level indicators located at all stations. Auto leveling standard.

Engine

Cummins QSM402 T3 six-cylinder, turbo-charged and after cooled diesel engine, 10,8 L (661 cu in), 300 kW (402 bhp) (gross) at 1800 rpm. Maximum torque 1898 Nm (1400 ft lb) at 1400 rpm. “Off Highway” EPA compliant.

Equipped with engine compression brake, audio-visual engine distress system and ether cold start aid.

*Optional engine

Cummins ISM450 07 six-cylinder, turbo-charged and after cooled diesel engine, 10,8 L (661 cu. in.), 336 kW (450 bhp) (gross) at 2000 rpm. Maximum torque 2102 Nm (1550 ft lb) at 1200 rpm. “On Highway” EPA compliant.

Equipped with engine compression brake, audio-visual engine distress system and ether cold start aid.

Fuel tank capacity

376 L (100 gal)

Transmission

Roadranger 11 speeds forward, 3 reverse.

Steering

Front axle, single circuit, mechanical steering with hydraulic power assist. Turning radius: 45.1 ft

Axles

Front: (2) beam-type steering axles, 2,12 m (83.4 in) track.

Rear: (2) single reduction drive axles, 1,89 m (74.5 in) track. Inter-axle differential locks.

Drive: 8 x 4 x 4.

Brakes

S-cam, dual air split system operating on all wheels. Spring-applied, air released parking brake acting on rear axles. Air dryer.

ABS with traction control.

Specifications

Carrier continued



Suspension

Front: Walking beam with air bags and shock absorbers.
Rear: Walking beam with air bags and shock absorbers.



Tires

Front: 445/65R 22.5 tubeless, mounted on aluminum disc wheels.

Rear: 315/80R 22.5 tubeless, mounted on aluminum disc outer wheels, inner wheels steel.



Lights

Full lighting package including turn indicators, head, tail, brake, and hazard warning lights.
Meets FMVSS and CMVSS standards.



Cab

One man design, aluminum fabricated with acoustical lining and tinted safety glass throughout. Deluxe fabric covered seat with air adjustment. Complete driving controls and engine instrumentation including tilt telescope steering wheel, tachometer, speedometer, voltmeter, water temp., oil pressure, fuel level, air pressure gauge, engine high temp./low oil pressure A/V warning. Other standard items include hot heater, heater/defroster, electric windshield wash/wipe, fire extinguisher, seat belt and door lock.



Electrical system

Four maintenance-free batteries provide 24 V electrical system. Standard battery disconnect.



Maximum speed

105 kph (65 MPH)



Gradeability (theoretical)

70%

Miscellaneous standard equipment

Aluminum fenders with rear storage compartments; dual rear view mirrors; electronic back-up alarm; sling/tool box; tire inflation kit; air cleaner restriction indicator; headache ball stowage; aluminum wheels; air conditioning; traction control; air horn

* Optional equipment

- ▶ Auxiliary Lighting and Convenience Package: Includes amber strobe light for superstructure and carrier cab, work light mounted on base boom section, and boom mounted aircraft warning light (fully wired)
- ▶ Dual boom base mounted floodlights
- ▶ Hookblocks
- ▶ Pintle hook (rear)
- ▶ Trailing Boom Package
- ▶ Aluminum outrigger pads
- ▶ Counterweight packages
- ▶ Tow cable
- ▶ Wind speed indicator
- ▶ Winterfront radiator cover
- ▶ Additional storage
- ▶ Counterweight slings
- ▶ Cross axle differential locks
- ▶ 360° house lock

Dimensions

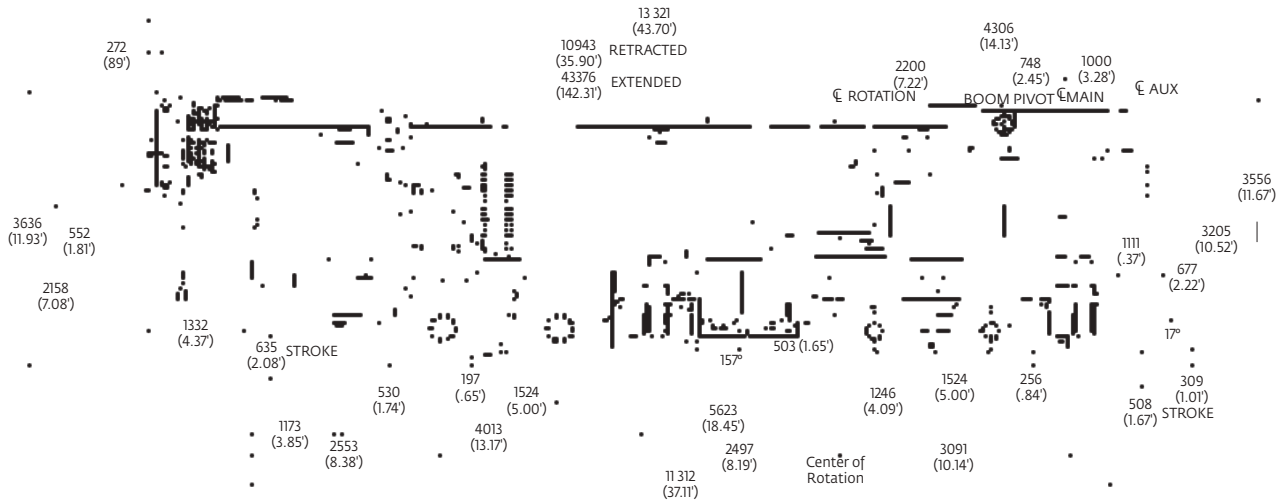
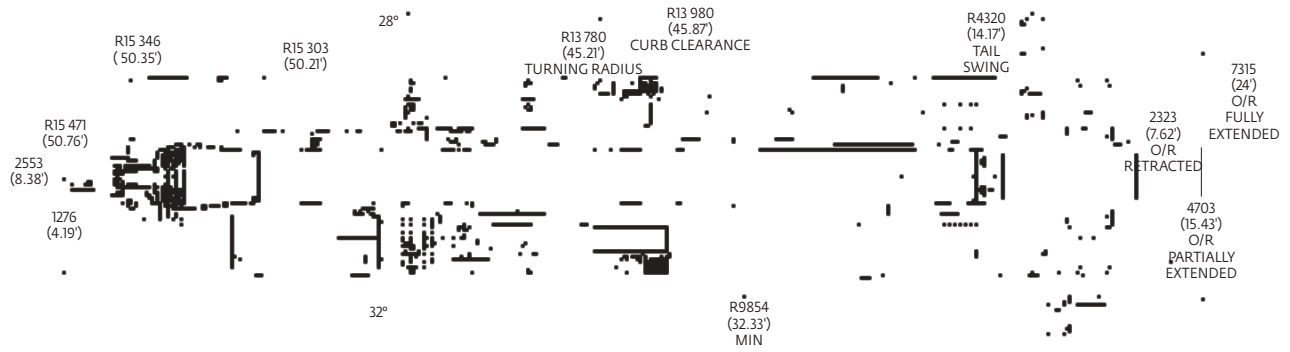

Dimensions shown in mm (ft)

Counterweight

Counterweight configurations

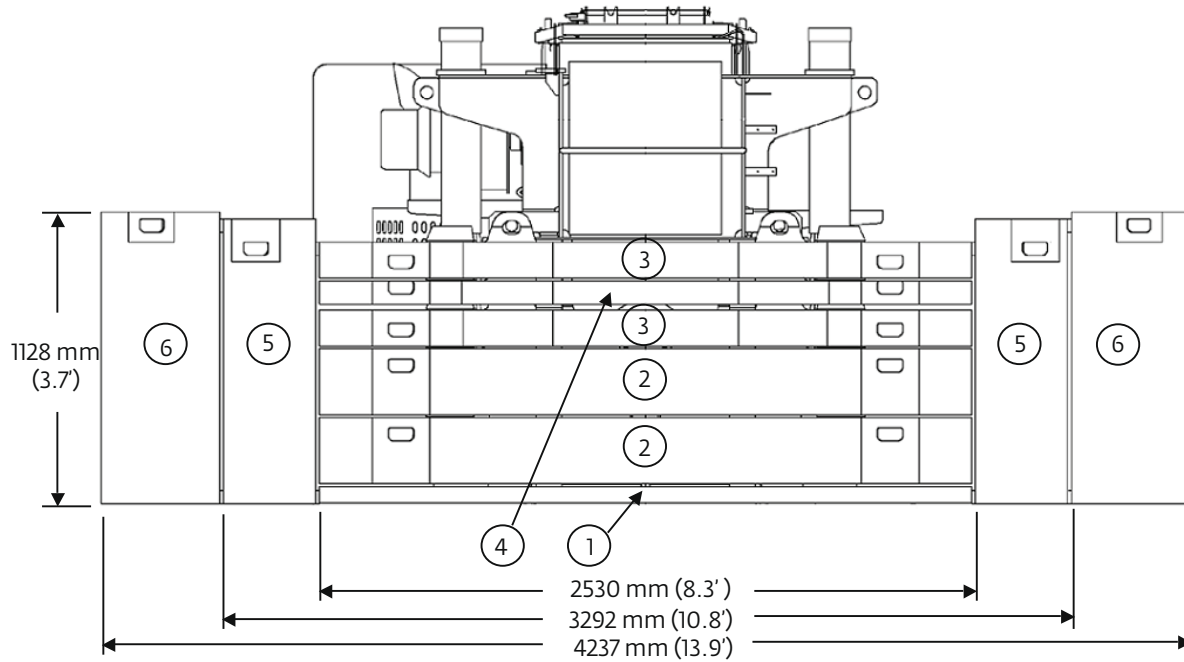

- 1. 3000 lb baseplate
- 2. 10,000 lb stackable
- 3. 5000 lb pinned or stackable
- 4. 3000 lb pinned or stackable
- 5. 4000 lb wing
- 6. 2250 lb wing

Load chart configurations						
	1	2	3	4	5	6
0						
6000 lb	X			X		
11,000 lb	X		X	X		
16,000 lb	X		2X	X		
21,000 lb	X	X	X	X		
26,000 lb	X	X	2X	X		
36,000 lb	X	2X	2X	X		
44,000 lb	X	2X	2X	X	2X	
48,500 lb	X	2X	2X	X	2X	2X

Travel proposals

Boom over front

	Front (lb)	Rear (lb)	G.V.W. (lb)
Basic machine: Includes main and auxiliary hoists with rope, auxiliary boom nose, manual bi-fold swingaway, headache ball stowed, 40 UST hookblock at bumper, no counterweight and driver.	43,129	40,843	83,972
Add: 3000 lb counterweight on carrier deck and 3000 lb counterweight on superstructure. Total counterweight 6000 lb.	44,459	49,532	89,991
Add: 6000 lb counterweight on carrier deck and 3000 lb counterweight on superstructure. Total counterweight 9000 lb.	47,087	45,923	93,010
Add: 8000 lb counterweight on carrier deck and 8000 lb counterweight on superstructure. Total counterweight 16000 lb.	46,699	53,330	100,029
Add: 13,000 lb counterweight, 13,000 lb counterweight on superstructure. Boom telescoped 2 ft. Total counterweight 26,000 lb.	50,405	59,624	110,029
Air conditioning - chassis and superstructure cabs	99	19	118
Hydraulic bi-fold swingaway in lieu of the manual swingaway (includes hose reel)	408	-13	395
Maximum allowable Michelin tires	49,200 51,200	60,000 60,000	109,200 111,200

Trailing boom dolly

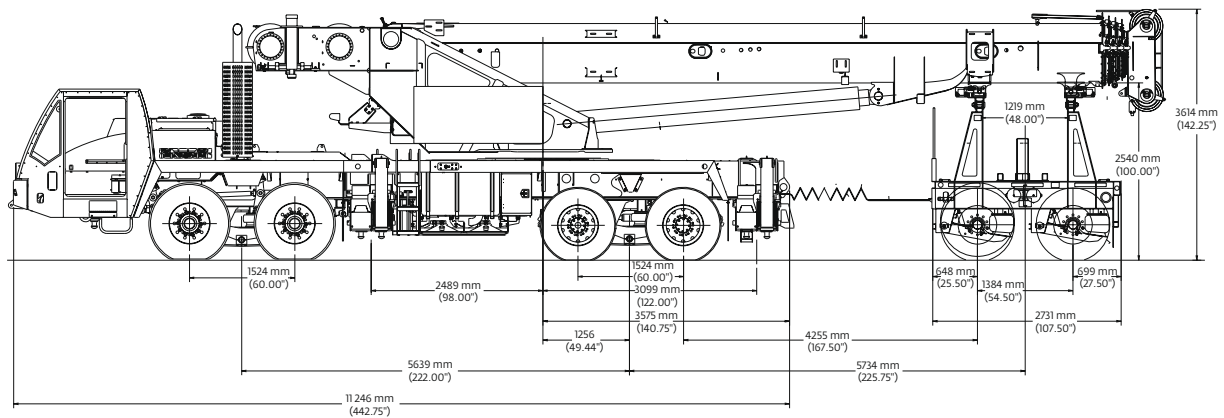

Unit configuration

	Front (lb)	Rear (lb)	Boom Dolly (lb)	G.V.W. (lb)
Basic machine: Includes main and auxiliary hoists with rope, auxiliary boom nose, manual bi-fold swingaway, stowed headache ball, 40 UST hookblock hanging at boom nose, no counterweight, driver and 6000 lb boom dolly.	35,797	32,223	21,952	89,972
Add: 6000 lb counterweight on front chassis deck, 5000 lb counterweight on rear chassis counterweight carrier, 15,000 lb on boom dolly. Total counterweight 26,000 lb.	39,416	39,856	36,971	116,243
Add: 8000 lb counterweight on front chassis deck, 5000 lb counterweight on rear chassis counterweight carrier, 23,000 lb on boom dolly. Total counterweight 36,000 lb.	41,157	40,115	45,009	126,281
Air conditioning - chassis and superstructure cabs	104	14	-	118
Hydraulic bi-fold swingaway in lieu of the manual swingaway (includes hose reel)	64	39	291	395

THIS CHART IS ONLY A GUIDE AND SHOULD NOT BE USED TO OPERATE THE CRANE.

Grove TMS9000E The individual crane's load chart, operating instructions and other instructional plates must be read and understood prior to operating the crane.

Working range

36 ft - 142 ft main boom and manual lattice extension

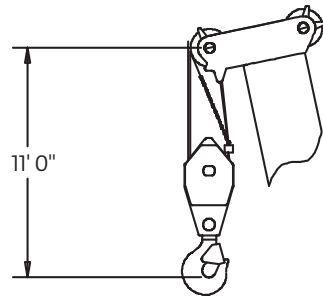
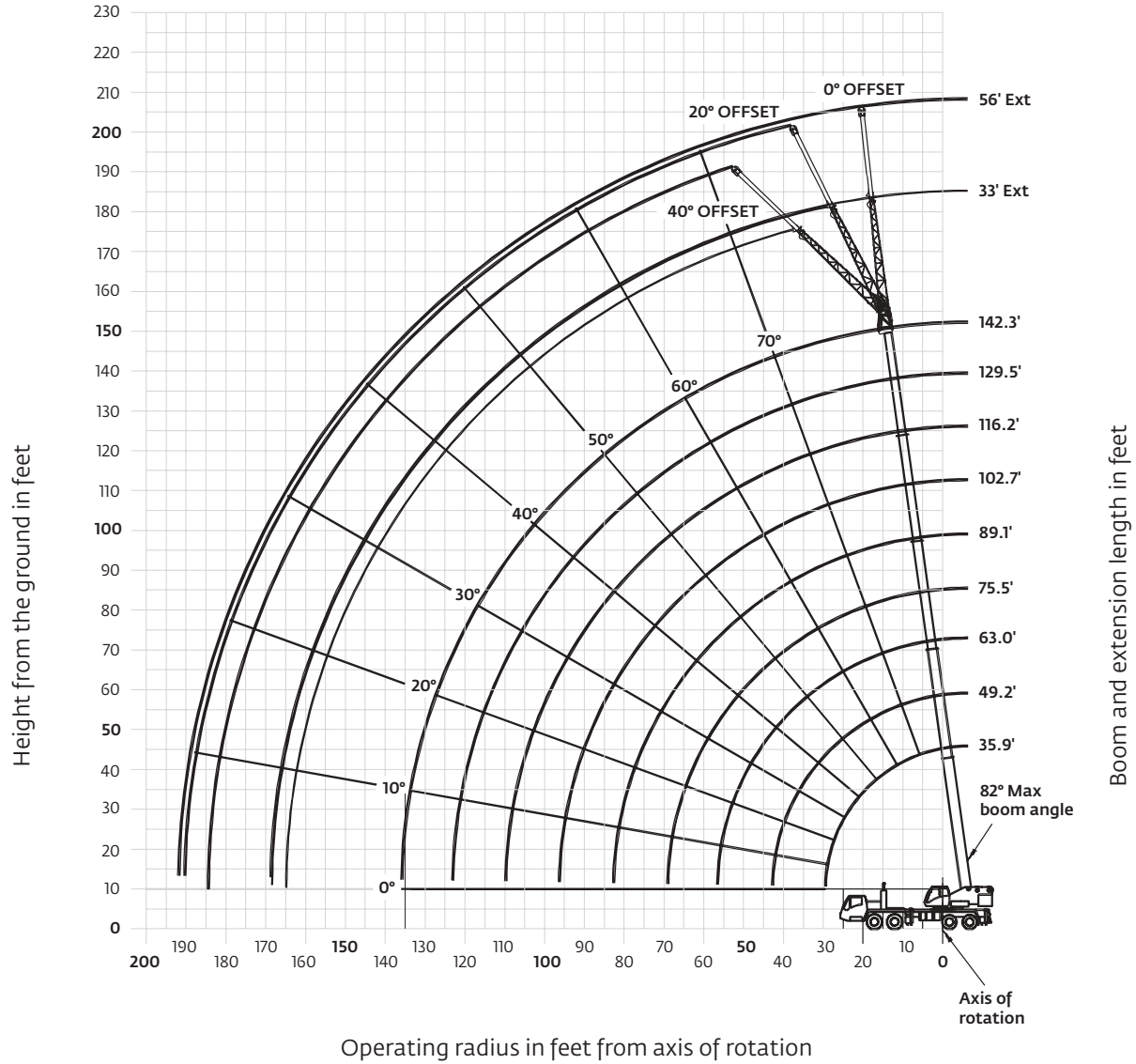

Dimensions area for largest Grove furnished hookblock and headache ball, with anti-two block activated.

THIS CHART IS ONLY A GUIDE AND SHOULD NOT BE USED TO OPERATE THE CRANE.

The individual crane's load chart, operating instructions and other instructional plates must be read and understood prior to operating the crane.

Load charts

 **36 ft - 142 ft**
Fixed lengths

 **48,500 lb**

 **100%**
24 ft 0 in

 **360°**

		Pounds (thousands)								
Feet	35.9'	49.2'	63.0'	75.5'	89.1'	102.7'	116.2'	129.5'	142.3'	
8	*220,000									
9	*185,000									
10	165,000	138,000	130,500	111,000	83,000					
12	151,000	138,000	129,500	111,000	83,000					
15	131,500	127,500	122,500	111,000	83,000	60,150				
20	105,500	105,500	101,000	99,400	81,500	60,150	44,500	33,450		
25	83,600	85,750	84,300	84,550	73,500	56,750	44,500	33,450	26,700	
30		70,150	70,600	70,350	65,600	50,100	44,250	33,450	26,700	
35		58,050	58,600	57,850	59,150	44,700	40,100	33,450	26,700	
40		48,050	48,950	48,250	49,550	40,150	36,250	32,850	26,700	
45			41,600	43,050	42,250	36,350	32,400	30,050	26,700	
50			37,000	37,450	36,600	32,650	29,550	27,550	25,950	
55			27,450	32,650	31,950	30,250	27,050	25,300	24,100	
60				28,700	27,950	28,200	24,900	23,350	22,350	
65				25,350	24,700	25,400	23,000	21,550	20,750	
70					22,100	22,700	21,200	20,000	19,300	
75					20,850	20,400	19,500	18,600	18,000	
80					19,100	18,450	18,400	16,650	16,100	
85						16,700	16,750	15,550	15,100	
90						15,250	15,600	14,300	14,150	
95						11,500	14,250	13,400	13,300	
100							13,050	12,700	12,350	
105							12,000	11,950	11,350	
110								11,000	10,400	
115								10,100	9,570	
120								9,360	8,780	
125									8,070	
130									7,420	
135									4,980	
140										

*Requires special equipment.

 **36 ft - 142 ft**
Fixed lengths

 **44,000 lb**

 **100%**
24 ft 0 in

 **360°**

		Pounds (thousands)								
Feet	35.9'	49.2'	63.0'	75.5'	89.1'	102.7'	116.2'	129.5'	142.3'	
10	165,000	138,000	130,500	111,000	83,000					
12	151,000	138,000	129,500	111,000	83,000					
15	131,500	127,500	122,500	111,000	83,000	60,150				
20	105,500	105,500	101,000	99,400	81,500	60,150	44,500	33,450		
25	82,900	84,900	83,600	84,550	73,500	56,750	44,500	33,450	26,700	
30		68,050	68,650	68,200	65,600	50,100	44,250	33,450	26,700	
35		56,000	56,450	55,700	57,050	44,700	40,100	33,450	26,700	
40		46,500	47,100	47,450	47,700	40,150	36,250	32,850	26,700	
45			40,300	41,500	40,650	36,350	32,400	30,050	26,700	
50			35,600	35,550	34,700	32,650	29,550	27,550	25,950	
55				30,800	30,050	30,250	27,050	25,300	24,100	
60			27,450	27,000	26,250	27,000	24,900	23,350	22,350	
65				23,850	23,550	23,850	22,350	21,550	20,750	
70					22,050	21,300	20,700	20,000	19,300	
75					19,800	19,100	19,400	18,050	18,000	
80					17,900	17,250	17,500	16,150	16,100	
85						15,650	15,950	15,050	15,100	
90						14,250	14,550	14,200	13,800	
95						11,500	13,250	13,150	12,550	
100							12,150	12,050	11,450	
105							11,100	11,050	10,450	
110								10,150	9,570	
115								9,330	8,760	
120								8,590	8,010	
125									7,330	
130									6,720	
135									4,980	
140										

THIS CHART IS ONLY A GUIDE AND SHOULD NOT BE USED TO OPERATE THE CRANE.

Grove TMS9000E The individual crane's load chart, operating instructions and other instructional plates must be read and understood prior to operating the crane.

Load charts

 36 ft - 142 ft
Fixed lengths

 26,000 lb

 100%
24 ft 0 in

 360°



Pounds (thousands)

Feet	35.9'	49.2'	63.0'	75.5'	89.1'	102.7'	116.2'	129.5'	142.3'
10	165,000	138,000	130,500	111,000	83,000				
12	151,000	138,000	129,500	111,000	83,000				
15	128,500	127,500	122,500	111,000	83,000	60,150			
20	95,750	97,750	96,300	97,600	81,500	60,150	44,500	33,450	
25	72,700	74,650	75,250	74,750	73,500	56,750	44,500	33,450	26,700
30		58,850	59,100	59,700	59,750	50,100	44,250	33,450	26,700
35		46,850	47,850	47,700	46,800	44,700	40,100	33,450	26,700
40		37,500	38,650	38,500	37,650	38,350	36,250	32,850	26,700
45			32,100	31,950	31,900	32,000	30,300	30,050	26,700
50			27,150	27,100	27,850	27,050	27,350	25,900	25,950
55			21,850	24,250	24,050	23,250	23,550	23,350	22,700
60				21,300	20,950	21,250	20,500	20,350	19,700
65				18,750	18,450	18,700	18,300	17,850	17,200
70					16,400	16,600	16,200	15,900	15,250
75					14,750	14,950	14,550	14,150	13,500
80					13,350	13,400	13,000	12,600	11,950
85						12,050	11,650	11,250	10,600
90						10,900	10,500	10,100	9,470
95						7430	9480	9070	8450
100							8580	8170	7550
105							7770	7360	6740
110								6640	6020
115								6000	5380
120								5400	4790
125									4260
130									3770
135									3330
140									

 36 ft - 142 ft
Fixed lengths

 11,000 lb

 100%
24 ft 0 in

 360°



Pounds (thousands)

Feet	35.9'	49.2'	63.0'	75.5'	89.1'	102.7'	116.2'	129.5'	142.3'
10	164,000	138,000	130,500	111,000	83,000				
12	147,000	138,000	129,500	111,000	83,000				
15	120,500	123,000	121,000	111,000	83,000	60,150			
20	84,900	86,900	87,500	86,750	81,500	60,150	44,500	33,450	
25	61,950	63,550	63,850	65,650	64,500	56,750	44,500	33,450	26,700
30		46,400	47,550	47,400	46,400	45,400	44,250	33,450	26,700
35		35,500	36,500	36,350	37,300	36,350	35,850	33,450	26,700
40			29,250	30,400	30,000	30,000	29,500	29,350	26,700
45			24,100	25,000	24,650	24,950	24,500	23,950	23,200
50			20,000	20,900	20,850	20,800	20,350	19,900	19,150
55			15,200	17,750	17,650	17,650	17,200	16,750	16,000
60				15,300	15,250	15,250	14,800	14,350	13,700
65				13,250	13,200	13,200	12,800	12,350	11,700
70					11,500	11,500	11,100	10,700	10,050
75					10,100	10,100	9730	9310	8660
80					8920	8930	8530	8110	7470
85						7890	7500	7080	6450
90						7000	6600	6190	5560
95						3750	5810	5400	4770
100							5120	4700	4080
105							4490	4090	3470
110								3530	2910
115								3040	2420
120								2580	1970
125									1560
130									1190
135									
140									

THIS CHART IS ONLY A GUIDE AND SHOULD NOT BE USED TO OPERATE THE CRANE.

The individual crane's load chart, operating instructions and other instructional plates must be read and understood prior to operating the crane.

Load charts

 36 ft - 142 ft
Fixed lengths

 0 lb

 100%
24 ft 0 in

 360°



Pounds (thousands)

Feet	35.9'	49.2'	63.0'	75.5'	89.1'	102.7'	116.2'	129.5'	142.3'
10	158,500	138,000	130,500	111,000	83,000				
12	141,500	138,000	129,500	111,000	83,000				
15	110,000	112,000	111,500	111,000	83,000	60,150			
20	75,800	77,850	78,200	78,900	79,000	60,150	44,500	33,450	
25	48,000	50,650	51,950	51,750	50,650	49,800	44,500	33,450	26,700
30		35,900	37,100	38,400	37,950	37,550	37,350	33,450	26,700
35		26,450	27,850	28,900	28,850	28,850	28,300	27,750	26,700
40		20,350	21,600	22,600	22,550	22,550	22,050	21,500	20,700
45			17,300	18,200	18,150	18,150	17,700	17,150	16,400
50			14,150	15,050	15,000	15,000	14,550	14,100	13,350
55			10,000	12,550	12,500	12,500	12,100	11,650	10,950
60				10,600	10,550	10,550	10,150	9,710	9,030
65				9,040	8,980	8,980	8,570	8,140	7,470
70					7,670	7,670	7,260	6,840	6,180
75					6,570	6,560	6,160	5,740	5,090
80					5,620	5,620	5,230	4,810	4,170
85						4,820	4,420	4,010	3,370
90						4,120	3,720	3,310	2,680
95						1,050	3,100	2,690	2,070
100							2,560	2,150	1,530
105							2,070	1,670	1,050
110								1,240	
115									
120									

THIS CHART IS ONLY A GUIDE AND SHOULD NOT BE USED TO OPERATE THE CRANE.

Grove TMS9000E The individual crane's load chart, operating instructions and other instructional plates must be read and understood prior to operating the crane.

Working range

36 ft - 142 ft manual lattice extension and two 16 ft inserts

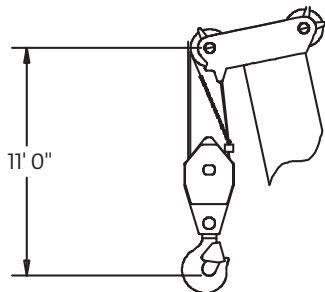
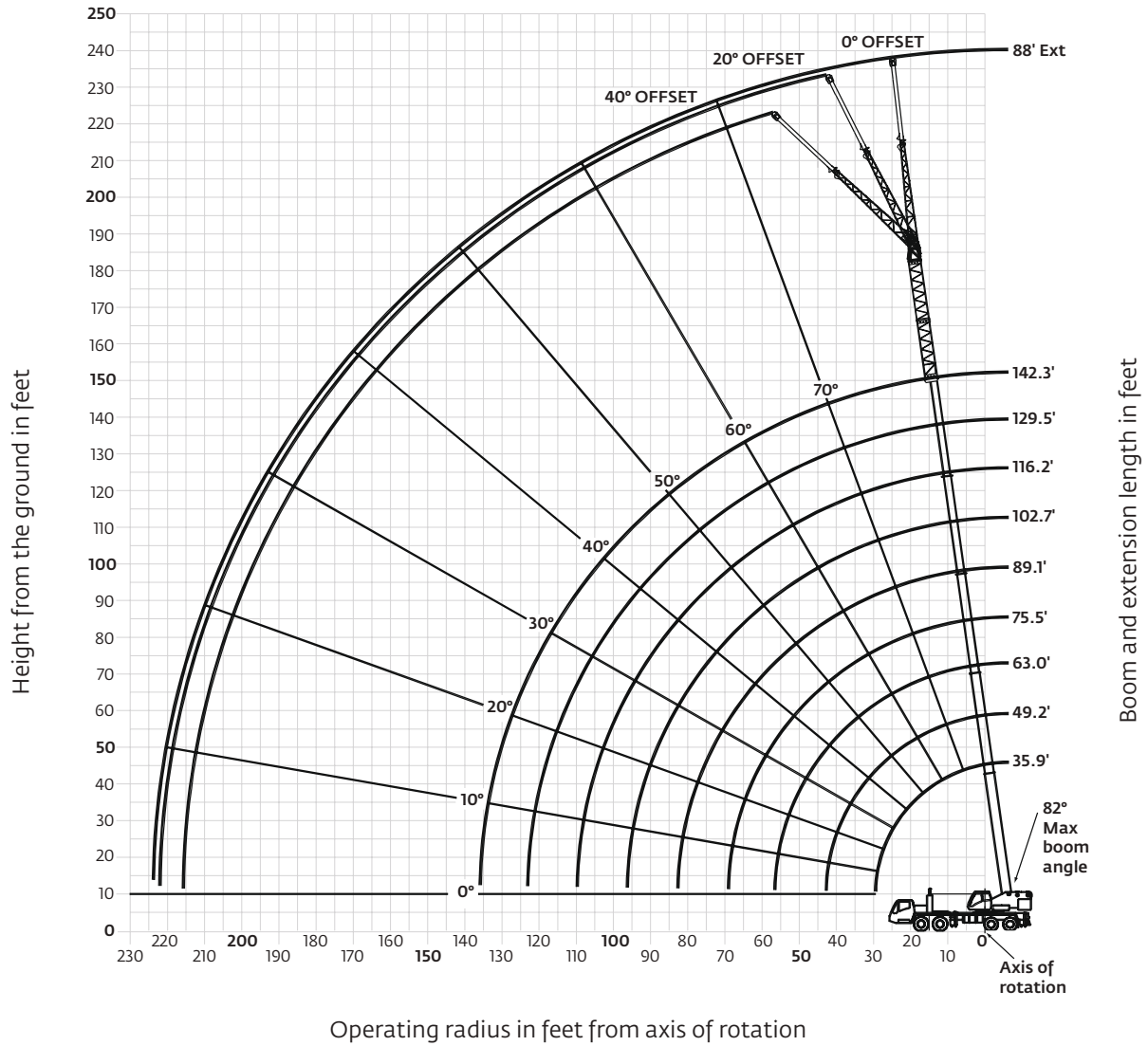





Dimensions area for largest Grove furnished hookblock and headache ball, with anti-two block activated.

THIS CHART IS ONLY A GUIDE AND SHOULD NOT BE USED TO OPERATE THE CRANE.

The individual crane's load chart, operating instructions and other instructional plates must be read and understood prior to operating the crane.

Load charts

 142 ft
Fixed lengths
  33 ft - 56 ft
72 ft - 88 ft
Manual offsettable
swingaway
  48,500 lb
  100%
24 ft 0 in
  360°



Pounds (thousands)

Feet	142.3' + 33'			142.3' + 56'			142.3' + 72'			142.3' + 88'		
	0°	20°	40°	0°	20°	40°	0°	20°	40°	0°	20°	40°
30	13,650			8470								
35	13,650			8470								
40	13,650			8470								
45	13,650	14,200		8470			6920					
50	13,650	14,200	12,200	8470			6920			5520		
55	13,650	14,200	12,200	8470	8700		6920			5520		
60	13,650	14,200	12,200	8470	8670		6920	7440		5520		
65	13,650	14,200	12,200	8470	8620		6920	7440		5520		
70	13,650	14,100	12,200	8470	8380		6920	7440		5520	5680	
75	13,650	13,500	12,200	8470	8160	6750	6920	7440	6370	5520	5610	
80	12,950	12,900	12,200	8470	7940	6640	6920	7440	6370	5520	5550	5330
85	12,250	12,250	12,200	8470	7720	6530	6920	7430	6370	5520	5480	5330
90	11,600	11,600	11,850	8470	7530	6440	6920	7330	6370	5520	5420	5330
95	11,000	11,050	11,250	8470	7340	6350	6920	7240	6350	5520	5350	5330
100	10,450	10,500	10,700	8470	7170	6280	6920	7140	6270	5520	5290	5290
105	9860	9990	10,200	8470	7020	6210	6920	7040	6200	5440	5230	5240
110	9290	9510	9720	8340	6870	6140	6920	6840	6140	5350	5160	5200
115	8750	8980	9260	8100	6730	6090	6920	6630	6090	5270	5100	5150
120	8250	8470	8720	7770	6610	6050	6710	6430	6040	5180	5040	5110
125	7790	7990	8210	7420	6490	6010	6490	6240	6000	5100	4990	5050
130	7260	7520	7610	7090	6390	5990	6270	6050	5970	5010	4920	4990
135	6670	6890		6770	6290	5970	6020	5880	5950	4930	4850	4920
140	6130	6320		6460	6200	5970	5740	5710	5800	4840	4760	4860
145	5630	5780		6070	6130	5970	5470	5560	5660	4670	4600	4720
150	5160	5280		5600	6000	5970	5220	5410	5530	4520	4460	4580
155	4740	4820		5160	5520	5660	4980	5180	5410	4360	4320	4450
160	4340			4750	5070		4590	4950	5180	4220	4190	4320
165	3990			4370	4640		4200	4560	4720	4020	4060	4200
170				4020	4240		3840	4160		3760	3950	4090
175				3690	3860		3500	3790		3420	3770	3930
180				3380	3500		3190	3430		3100	3420	3550
185				3080			2890	3100		2800	3090	
190				1830			2620	2780		2510	2770	
195							2360	2480		2250	2470	
200							2120			2000	2190	
205							1910			1770	1920	
210										1550	1660	
215										1340		
220										1160		

THIS CHART IS ONLY A GUIDE AND SHOULD NOT BE USED TO OPERATE THE CRANE.

Grove TMS9000E The individual crane's load chart, operating instructions and other instructional plates must be read and understood prior to operating the crane.

Load charts

 142 ft
Fixed lengths

 33 ft - 56 ft
72 ft - 88 ft
Manual offsettable
swingaway

 44,000 lb

 100%
24 ft 0 in

 360°



Pounds (thousands)

Feet	142.3' + 33'			142.3' + 56'			142.3' + 72'			142.3' + 88'		
	0°	20°	40°	0°	20°	40°	0°	20°	40°	0°	20°	40°
30	13,650											
35	13,650			8470								
40	13,650			8470								
45	13,650	14,200		8470			6920					
50	13,650	14,200	12,200	8470			6920			5520		
55	13,650	14,200	12,200	8470	8700		6920			5520		
60	13,650	14,200	12,200	8470	8670		6920	7440		5520		
65	13,650	14,200	12,200	8470	8620		6920	7440		5520		
70	13,650	14,100	12,200	8470	8380		6920	7440		5520	5680	
75	13,650	13,500	12,200	8470	8160	6750	6920	7440	6370	5520	5610	
80	12,950	12,900	12,200	8470	7940	6640	6920	7440	6370	5520	5550	5330
85	12,250	12,250	12,200	8470	7720	6530	6920	7430	6370	5520	5480	5330
90	11,600	11,600	11,850	8470	7530	6440	6920	7330	6370	5520	5420	5330
95	11,000	11,050	11,250	8470	7340	6350	6920	7240	6350	5520	5350	5330
100	10,450	10,500	10,700	8470	7170	6280	6920	7140	6270	5520	5290	5290
105	9860	9990	10,200	8470	7020	6210	6920	7040	6200	5440	5230	5240
110	9290	9510	9720	8340	6870	6140	6920	6840	6140	5350	5160	5200
115	8580	8940	9140	8100	6730	6090	6920	6630	6090	5270	5100	5150
120	7850	8170	8330	7770	6610	6050	6710	6430	6040	5180	5040	5110
125	7170	7460	7590	7420	6490	6010	6490	6240	6000	5100	4990	5050
130	6560	6810	6910	7040	6390	5990	6270	6050	5970	5010	4920	4990
135	5990	6220		6460	6290	5970	6020	5880	5950	4930	4850	4920
140	5480	5660		5940	6200	5970	5740	5710	5800	4840	4760	4860
145	5000	5150		5450	5890	5970	5300	5560	5660	4670	4600	4720
150	4560	4680		5000	5400	5590	4840	5320	5530	4520	4460	4580
155	4150	4240		4580	4930	5080	4420	4860	5090	4340	4320	4450
160	3780			4190	4500		4020	4420	4620	3950	4190	4320
165	3440			3830	4090		3660	4020	4170	3580	4000	4200
170				3490	3710		3310	3630		3230	3620	3810
175				3170	3350		2990	3280		2900	3260	3420
180				2880	3000		2690	2940		2600	2920	3050
185				2620			2410	2620		2310	2600	
190				1830			2150	2310		2040	2300	
195							1900	2020		1790	2010	
200							1680			1560	1740	
205							1480			1330	1480	
210										1120	1230	

 142 ft
Fixed lengths

 33 ft - 56 ft
72 ft - 88 ft
Manual offsettable
swingaway

 26,000 lb

 100%
24 ft 0 in

 360°



Pounds (thousands)

Feet	142.3' + 33'			142.3' + 56'			142.3' + 72'			142.3' + 88'		
	0°	20°	40°	0°	20°	40°	0°	20°	40°	0°	20°	40°
30	13,650											
35	13,650			8470								
40	13,650			8470								
45	13,650	14,200					6920					
50	13,650	14,200	12,200	8470			6920			5520		
55	13,650	14,200	12,200	8470	8700		6920			5520		
60	13,650	14,200	12,200	8470	8670		6920	7440		5520		
65	13,650	14,200	12,200	8470	8620		6920	7440		5520		
70	13,650	14,100	12,200	8470	8380		6920	7440		5520	5680	
75	13,400	13,500	12,200	8470	8160	6750	6920	7440	6370	5520	5610	
80	11,900	12,600	12,200	8470	7940	6640	6920	7440	6370	5520	5550	5330
85	10,550	11,200	11,650	8470	7720	6530	6920	7430	6370	5520	5480	5330
90	9380	9990	10,400	8470	7530	6440	6920	7330	6370	5520	5420	5330
95	8350	8900	9260	8470	7340	6350	6920	7240	6350	5520	5350	5330
100	7440	7940	8250	8000	7170	6280	6920	7140	6270	5520	5290	5290
105	6620	7070	7350	7180	7020	6210	6920	7040	6200	5440	5230	5240
110	5890	6300	6540	6430	6870	6140	6330	6840	6140	5350	5160	5200
115	5240	5600	5800	5760	6540	6090	5650	6490	6090	5270	5100	5150
120	4640	4970	5130	5160	5870	6050	5040	5820	6040	5000	5040	5110
125	4100	4390	4520	4600	5260	5700	4480	5200	5720	4440	4990	5050
130	3600	3860	3960	4100	4700	5090	3970	4640	5100	3930	4650	4990
135	3150	3380		3640	4190	4520	3510	4120	4540	3450	4130	4590
140	2740	2930		3210	3710	4000	3070	3650	4010	3020	3650	4070
145	2350	2510		2820	3270	3510	2680	3210	3530	2620	3200	3590
150	2000	2130		2460	2860	3060	2310	2800	3080	2250	2790	3130
155	1680	1770		2120	2480	2630	1970	2410	2650	1900	2410	2710
160	1390			1810	2130		1650	2060	2260	1580	2050	2320
165	1120			1520	1790		1360	1720	1880	1290	1710	1950
170				1250	1480		1080	1410		1010	1400	1600
175				1000	1180			1110		1110	1270	

THIS CHART IS ONLY A GUIDE AND SHOULD NOT BE USED TO OPERATE THE CRANE.

The individual crane's load chart, operating instructions and other instructional plates must be read and understood prior to operating the crane.

Working range

33 ft -56 ft hydraulic lattice extension with two 16 ft inserts

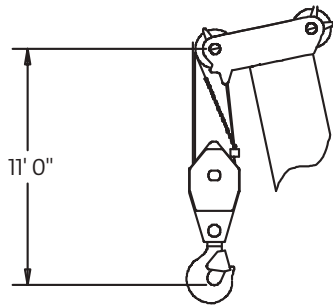
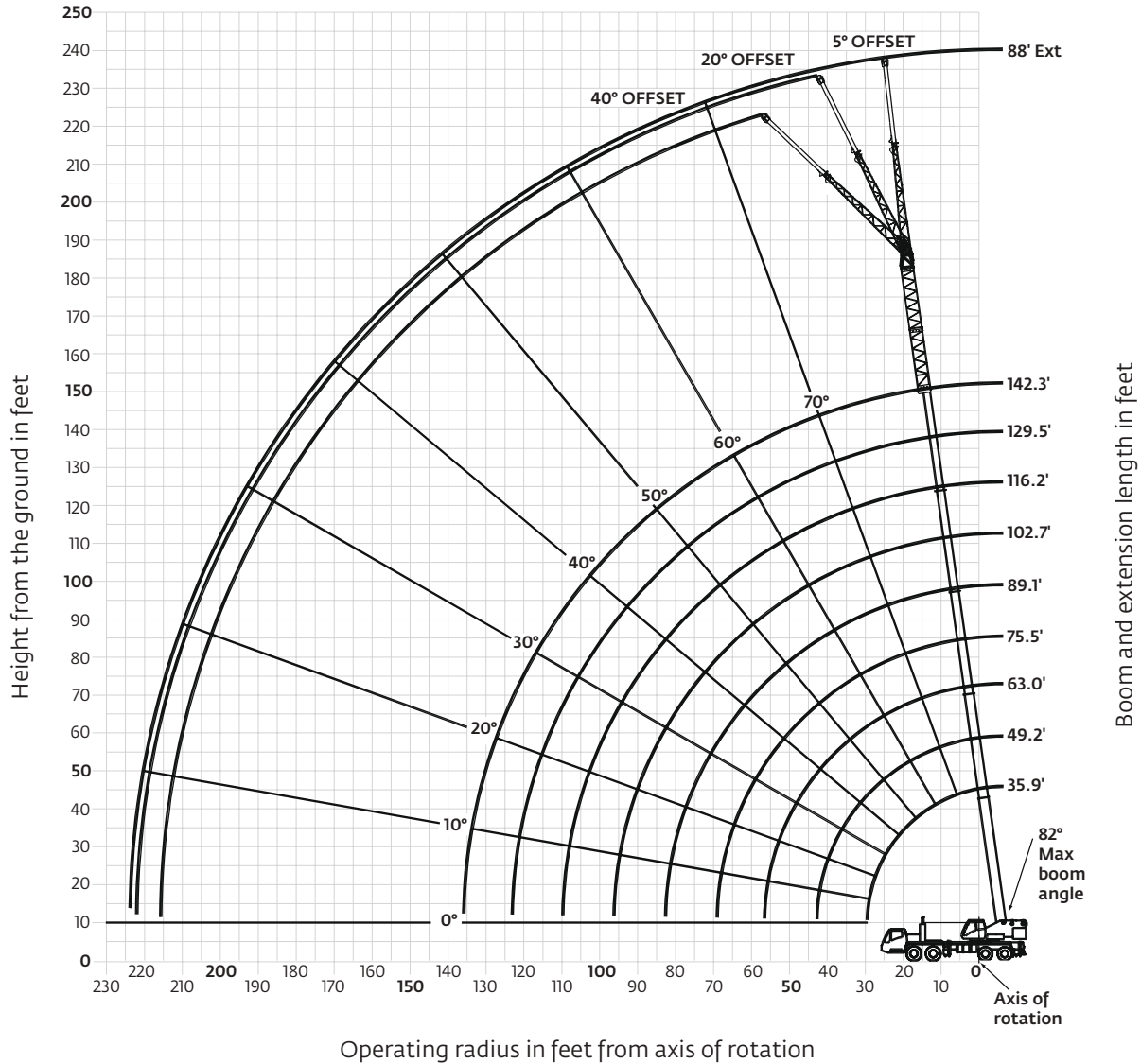

Dimensions area for largest Grove furnished hookblock and headache ball, with anti-two block activated.

THIS CHART IS ONLY A GUIDE AND SHOULD NOT BE USED TO OPERATE THE CRANE.

Load charts

 142 ft
Fixed lengths

 33 ft - 56 ft
72 ft - 88 ft
Hydraulic luffing
swingaway/stationary

 48,500 lb

 100%
24 ft 0 in

 360°



Pounds (thousands)

Feet	142.3' + 33'			142.3' + 56'			142.3' + 72'			142.3' + 88'		
	5°	5°-20°	20°-40°	5°	5°-20°	20°-40°	5°	5°-20°	20°-40°	5°	5°-20°	20°-40°
35	13,800											
40	13,800			8600								
45	13,800	13,800		8600								
50	13,800	13,800	12,200	8600			7000				5520	
55	13,800	13,800	12,000	8600	8600		7000				5520	
60	13,800	13,800	12,200	8600	8600		7000	7000			5520	
65	13,800	13,800	12,200	8600	8600		7000	7000			5520	
70	13,800	13,800	12,200	8600	8380		7000	7000			5520	5520
75	13,600	13,450	12,200	8600	8160	6750	7000	7000	6360		5520	5520
80	12,900	12,850	12,200	8600	7930	6640	7000	7000	6360		5520	5520
85	12,200	12,200	12,200	8600	7720	6530	7000	7000	6360		5520	5460
90	11,550	11,550	11,550	8600	7530	6440	7000	7000	6360		5520	5400
95	10,950	10,950	11,000	8600	7340	6350	7000	7000	6350		5520	5330
100	10,400	10,400	10,450	8370	7170	6270	7000	7000	6270		5440	5270
105	9870	9870	9940	8130	7010	6200	7000	7000	6200		5350	5210
110	9290	9290	9460	7890	6870	6140	7000	6810	6140		5270	5140
115	8750	8750	8930	7670	6730	6090	6800	6600	6090		5180	5080
120	8250	8250	8420	7460	6610	6050	6580	6400	6040		5100	5020
125	7780	7780	7940	7260	6490	6010	6360	6200	6000		5020	4970
130	7280	7280	7460	7080	6390	5990	6160	6020	5970		4940	4890
135	6680	6680		6760	6260	5970	5960	5840	5840		4860	4820
140	6130	6130		6470	6200	5970	5730	5680	5680		4760	4720
145	5620	5620		6150	6130	5970	5460	5460	5520		4600	4570
150	5150	5150		5660	5660	5950	5210	5210	5370		4450	4420
155	4710	4710		5210	5210	5470	4970	4970	5130		4300	4280
160	4310			4790	4790		4630	4630	4890		4160	4150
165	3940			4400	4400		4240	4240	4500		4020	4020
170				4040	4040		3870	3870			3800	3800
175					3690		3520	3520			3450	3450
180					3370		3200	3200			3120	3120
185					3040		2860	2860			2790	2790
190							2540	2540			2460	2460
195							2230	2230			2160	2160
200							1940				1870	1870
205							1660				1590	1590
210											1330	1330
215											1080	

THIS CHART IS ONLY A GUIDE AND SHOULD NOT BE USED TO OPERATE THE CRANE.

The individual crane's load chart, operating instructions and other instructional plates must be read and understood prior to operating the crane.

Load charts





 142 ft
Fixed lengths
  33 ft - 56 ft
72 ft - 88 ft
Hydraulic luffing
swingaway/loads luffing
  48,500 lb
  100%
24 ft 0 in
  360°

Feet	142.3' + 33'		142.3' + 56'		142.3' + 72'		142.3' + 88'	
	5°-20°	20°-40°	5°-20°	20°-40°	5°-20°	20°-40°	5°-20°	20°-40°
35								
40								
45	13,800							
50	13,800	12,200						
55	13,800	12,200	8130					
60	13,800	11,950	7790		7000			
65	13,350	11,700	7490		7000			
70	12,900	11,500	7210		6810		5520	
75	12,450	11,350	6940	6000	6600	5,470	5520	
80	12,100	11,150	6690	5880	6410	5380	5520	4960
85	11,750	11,000	6460	5760	6230	5290	5460	4890
90	11,400	10,850	6260	5660	6050	5210	5400	4820
95	10,950	10,750	6060	5550	5880	5140	5330	4760
100	10,400	10,450	5880	5460	5730	5070	5270	4700
105	9870	9940	5700	5380	5580	5000	5210	4640
110	9290	9460	5550	5300	5450	4940	5140	4590
115	8750	8930	5400	5230	5320	4880	5080	4540
120	8250	8420	5260	5170	5200	4830	5020	4500
125	7780	7940	5130	5110	5080	4780	4970	4450
130	7280	7460	5010	5010	4970	4730	4890	4410
135	6680		4900	4900	4870	4690	4810	4380
140	6130		4780	4790	4780	4660	4720	4340
145	5620		4630	4690	4690	4620	4570	4310
150	5150		4480	4610	4540	4600	4420	4290
155	4710		4340	4520	4410	4520	4280	4260
160			4220		4290	4450	4150	4150
165			4090		4170	4380	4020	4020
170			3980		3870		3800	3910
175			3690		3520		3450	3710
180			3370		3200		3120	3350
185					2860		2790	
190					2540		2460	
195					2230		2160	
200							1870	
205							1590	
210							1330	
215								

THIS CHART IS ONLY A GUIDE AND SHOULD NOT BE USED TO OPERATE THE CRANE.

Grove TMS9000E The individual crane's load chart, operating instructions and other instructional plates must be read and understood prior to operating the crane.

Load charts

 142 ft
Fixed lengths
  33 ft - 56 ft
72 ft - 88 ft
Hydraulic luffing
swingaway/stationary
  44,000 lb
  100%
24 ft 0 in
  360°

 Pounds (thousands)

Feet	142.3' + 33'			142.3' + 56'			142.3' + 72'			142.3' + 88'		
	5°	5°-20°	20°-40°	5°	5°-20°	20°-40°	5°	5°-20°	20°-40°	5°	5°-20°	20°-40°
35	13,800											
40	13,800			8600								
45	13,800	13,800		8600								
50	13,800	13,800	12,200	8600			7000			5520		
55	13,800	13,800	12,200	8600	8600		7000			5520		
60	13,800	13,800	12,200	8600	8600		7000	7000		5520		
65	13,800	13,800	12,200	8600	8600		7000	7000		5520		
65	13,800	13,800	12,200	8600	8600		7000	7000		5520		
70	13,800	13,800	12,200	8600	8380		7000	7000		5520	5520	
75	13,600	13,450	12,200	8600	8160	6750	7000	7000	6360	5520	5520	
80	12,900	12,850	12,200	8600	7930	6640	7000	7000	6360	5520	5520	5300
85	12,200	12,200	12,200	8600	7720	6530	7000	7000	6360	5520	5460	5300
90	11,550	11,550	11,550	8600	7530	6440	7000	7000	6360	5520	5400	5300
95	10,950	10,950	11,000	8600	7340	6350	7000	7000	6350	5520	5330	5300
100	10,400	10,400	10,450	8370	7170	6270	7000	7000	6270	5440	5270	5270
105	9870	9870	9940	8130	7010	6200	7000	7000	6200	5350	5210	5210
110	9290	9290	9460	7890	6870	6140	7000	6810	6140	5270	5140	5140
115	8630	8630	8890	7670	6730	6090	6800	6600	6090	5180	5080	5080
120	7880	7880	8110	7460	6610	6050	6580	6400	6040	5100	5020	5020
125	7200	7200	7400	7260	6490	6010	6360	6200	6000	5020	4970	4970
130	6580	6580	6750	7080	6390	5990	6160	6020	5970	4940	4890	4890
135	6000	6000		6560	6290	5970	5960	5840	5840	4860	4820	4820
140	5480	5480		6020	6020	5970	5730	5680	5680	4760	4720	4720
145	4990	4990		5520	5520	5850	5370	5370	5520	4600	4570	4570
150	4540	4540		5060	5060	5350	4910	4910	5260	4450	4420	4420
155	4130	4130		4630	4630	4890	4470	4470	4790	4300	4280	4280
160	3740			4230	4230		4070	4070	4360	4010	4010	4150
165	3390			3860	3860		3690	3690	3950	3630	3630	3930
170				3510	3510		3340	3340		3270	3270	3550
175				3180	3280		3010	3010		2940	2940	3190
180				2880	2880		2700	2700		2620	2620	2860
185				2590			2410	2410		2330	2330	
190							2130	2130		2050	2050	
195							1880	1880		1790	1790	
200							1600			1530	1530	
205							1330			1260	1260	
210										1010	1010	

Load charts

 142 ft
Fixed lengths
  33 ft - 56 ft
72 ft - 88 ft
Hydraulic luffing
swingaway/loads luffing
  44,000 lb
  100%
24 ft 0 in
  360°

Feet	142.3' + 33'		142.3' + 56'		142.3' + 72'		142.3' + 88'	
	5°-20°	20°-40°	5°-20°	20°-40°	5°-20°	20°-40°	5°-20°	20°-40°
35								
40								
45	13,800							
50	13,800	12,200						
55	13,800	12,200	8130					
60	13,800	11,950	7790		7000			
65	13,350	11,700	7490		7000			
70	12,900	11,500	7210		6810		5520	
75	12,450	11,350	6940	6000	6600	5470	5520	
80	12,100	11,150	6690	5880	6410	5380	5520	4960
85	11,750	11,000	6460	5760	6230	5290	5460	4890
90	11,400	10,850	6260	5660	6050	5210	5400	4820
95	10,950	10,750	6060	5550	5880	5140	5330	4760
100	10,400	10,450	5880	5460	5730	5070	5270	4700
105	9870	9940	5700	5380	5580	5000	5210	4640
110	9290	9460	5550	5300	5450	4940	5140	4590
115	8630	8890	5400	5230	5320	4880	5080	4540
120	7880	8110	5260	5170	5200	4830	5020	4500
125	7200	7400	5130	5110	5080	4780	4970	4450
130	6580	6750	5010	5010	4970	4730	4890	4410
135	6000		4900	4900	4870	4690	4810	4380
140	5480		4780	4790	4780	4660	4720	4340
145	4990		4630	4690	4690	4620	4570	4310
150	4540		4480	4610	4540	4600	4420	4290
155	4130		4340	4520	4410	4520	4280	4260
160			4220		4070	4360	4010	4150
165			3860		3690	3950	3630	3930
170			3510		3340		3270	3550
175			3180		3010		2940	3190
180			2880		2700		2620	2860
185					2410		2330	
190					2130		2050	
195					1880		1790	
200							1530	
205							1260	
210							1010	

THIS CHART IS ONLY A GUIDE AND SHOULD NOT BE USED TO OPERATE THE CRANE.

Load charts

 142 ft
Fixed lengths

 33 ft - 56 ft
72 ft - 88 ft
Hydraulic luffing
swingaway/stationary

 26,000 lb

 100%
24 ft 0 in

 360°



Pounds (thousands)

Feet	142.3' + 33'			142.3' + 56'			142.3' + 72'			142.3' + 88'		
	5°	5°-20°	20°-40°	5°	5°-20°	20°-40°	5°	5°-20°	20°-40°	5°	5°-20°	20°-40°
35	13,800											
40	13,800			8600								
45	13,800	13,800		8600								
50	13,800	13,800	12,200	8600			7000			5520		
55	13,800	13,800	12,200	8600	8600		7000			5520		
60	13,800	13,800	12,200	8600	8600		7000	7000		5520		
65	13,800	13,800	12,200	8600	8600		7000	7000		5520		
70	13,800	13,800	12,200	8600	8380		7000	7000		5520	5520	
75	13,550	13,450	12,200	8600	8160	6750	7000	7000	6360	5520	5520	
80	12,000	12,000	12,200	8600	7930	6640	7000	7000	6360	5520	5520	5300
85	10,650	10,650	11,150	8600	7720	6530	7000	7000	6360	5520	5460	5300
90	9490	9490	9930	8600	7530	6440	7000	7000	6360	5520	5400	5300
95	8450	8450	8850	8600	7340	6,350	7000	7000	6350	5520	5330	5300
100	7520	7520	7880	8220	7170	6270	7000	7000	6270	5440	5270	5270
105	6690	6690	7020	7370	7010	6200	7000	7000	6200	5350	5210	5210
110	5950	5950	6250	6610	6610	6140	6510	6510	6140	5270	5140	5140
115	5280	5280	5550	5920	5920	6090	5810	5810	6090	5180	5080	5080
120	4680	4680	4910	5300	5300	5820	5180	5180	5760	5100	5020	5020
125	4130	4130	4330	4730	4730	5210	4610	4610	5140	4580	4580	4970
130	3620	3620	3810	4210	4210	4650	4090	4090	4580	4050	4050	4580
135	3160	3160		3740	3740	4140	3610	3610	4060	3570	3570	4060
140	2740	2740		3300	3300	3670	3170	3170	3590	3120	3120	3580
145	2350	2350		2900	2900	3230	2760	2760	3140	2710	2710	3140
150	1990	1990		2520	2520	2820	2380	2380	2730	2330	2330	2730
155	1660	1660		2180	2180	2440	2030	2030	2350	1980	1980	2340
160	1350			1850	1850		1700	1700	1990	1650	1650	1990
165	1070			1550	1550		1400	1400	1660	1340	1340	1650
170				1270	1270		1110	1110		1050	1050	1340
175				1010	1010							1040

Load charts

 142 ft
 Fixed lengths

 33 ft - 56 ft
 72 ft - 88 ft
 Hydraulic luffing
 swingaway/loads luffing

 26,000 lb

 100%
 24 ft 0 in

 360°

Feet	Pounds (thousands)							
	142.3' + 33'		142.3' + 56'		142.3' + 72'		142.3' + 88'	
	5°-20°	20°-40°	5°-20°	20°-40°	5°-20°	20°-40°	5°-20°	20°-40°
35								
40								
45	13,800							
50	13,800	12,200						
55	13,800	12,200	8130					
60	13,800	11,950	7790		7000			
65	13,350	11,700	7490		7000			
70	12,900	11,500	7210		6810		5520	
75	12,450	11,350	6940	6000	6600	5470	5520	
80	12,000	11,150	6690	5880	6410	5380	5520	4960
85	10,650	11,000	6460	5760	6230	5290	5460	4890
90	9490	9930	6260	5660	6050	5210	5400	4820
95	8450	8850	6060	5550	5880	5140	5330	4760
100	7520	7880	5880	5460	5730	5070	5270	4700
105	6690	7020	5700	5380	5580	5000	5210	4640
110	5950	6250	5550	5300	5450	4940	5140	4590
115	5280	5550	5400	5230	5320	4880	5080	4540
120	4680	4910	5260	5170	5180	4830	5020	4500
125	4130	4330	4730	5110	4610	4780	4580	4450
130	3620	3810	4210	4650	4090	4580	4050	4410
135	3160		3740	4140	3610	4060	3570	4060
140	2740		3300	3670	3170	3590	3120	3580
145	2350		2900	3230	2760	3140	2710	3140
150	1990		2520	2820	2380	2730	2330	2730
155	1660		2180	2440	2030	2350	1980	2340
160			1850		1700	1990	1650	1990
165			1550		1400	1660	1340	1650
170			1270		1110		1050	1340
175			1010					1040

THIS CHART IS ONLY A GUIDE AND SHOULD NOT BE USED TO OPERATE THE CRANE.

Load handling

33 ft - 56 ft folding boom extension (luffing or manual)

657 lb hookblock

	Without	With
*33 ft extension (erected)	6600 lb	10,800 lb
*56 ft extension (erected)	12,300 lb	19,300 lb

*Reduction of main boom capacities

When lifting over main boom nose with 33 ft or 56 ft extension erected, the outriggers must be fully extended or 50% extended (15 ft 5 in spread)

NOTE: All load handling devices and boom attachments are considered part of the load and suitable allowances MUST BE MADE for their combined weights. Weights are for Grove furnished equipment.

Auxiliary boom nose	133 lb
---------------------	--------

Hookblocks and headache balls:

80 Ust, 5-sheave	1609 lb +
40 Ust, 3-sheave	823 lb +
25 Ust, 1-sheave	657 lb +
8.3 Ust, overhaul ball	355 lb +

+ Refer to rating plate for actual weight.

When lifting over extension and/or jib combinations, deduct total weight of all load handling devices reeved over main boom nose directly from swingaway or jib capacity.

Hoists	Cable specs	Permissible line pulls	Nominal cable length
Main and auxiliary	19 mm (3/4 in) Caser Eurolift Rotation Resistant Min. breaking strength 78,683 lb	15,736 lb	738 ft
Main and auxiliary	19 mm (3/4 in) 35x7 Class Rotation Resistant Min. breaking strength 85,800 lb	17,160 lb	702 ft

The approximate weight of 3/4 in wire rope is 1.5 lb/ft

Hoist performance

Wire rope layer	Hoist line pools Available lb ^o	Drum rope capacity (ft)	
		Layer	Total
1	22,122	109.95	109.95
2	20,247	120.14	230.09
3	18,665	130.32	360.41
4	17,312	140.50	500.91
5	16,142	150.68	651.59
6	15,120	160.87	812.46

*Max lifting capacity

19 mm Caser Eurolift: 15,736 lb

19 mm 35x7 Class: 17,160 lb



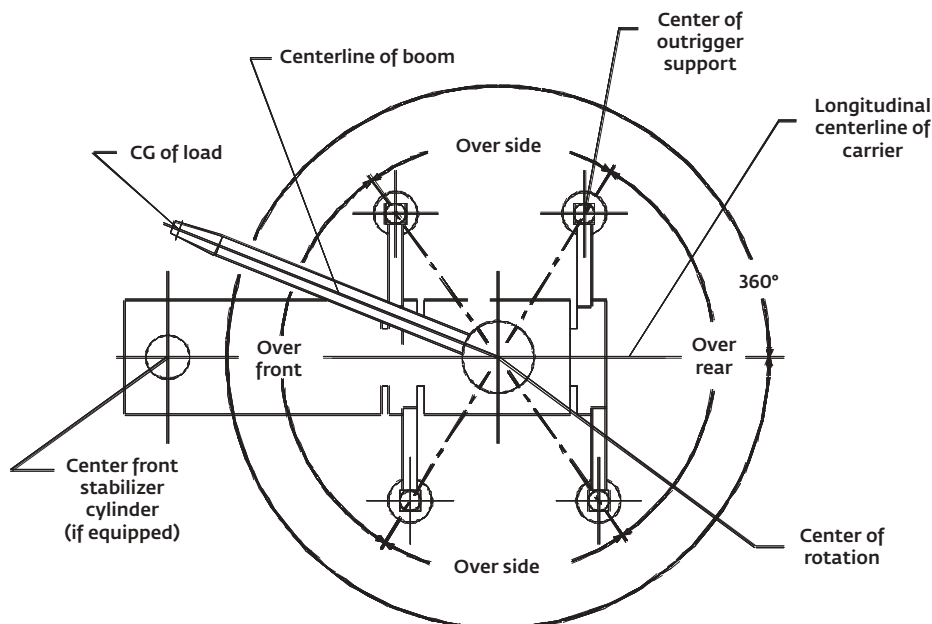































Working area diagram



6-829-005671

Bold lines determine the limiting position of any load for operation within working areas indicated.

Symbols glossary

 Axles	 Counterweight	 Grade	 Outriggers
 Boom	 Drive	 Height (no max)	 Radius
 Boom elevation	 Electrical system	 Heavy duty jib	 Rotation
 Boom extension	 Engine	 Hoist	 Speed
 Boom length	 Extension	 Hookblock	 Steering
 Boom nose	 Frame	 Hydraulic system	 Suspension
 Brakes	 Fuel tank capacity	 Lights	 Swing
 Cab	 Gear	 Oil	 Tires
		 Outrigger controls	 Transmission



Notes

Notes



Regional headquarters

Manitowoc - Americas

Manitowoc, Wisconsin, USA

Tel: +1 920 684 6621

Fax: +1 920 683 6277

Shady Grove, Pennsylvania, USA

Tel: +1 717 597 8121

Fax: +1 717 597 4062

Manitowoc - Europe, Middle East & Africa

Ecully, France

Tel: +33 (0)4 72 18 20 20

Fax: +33 (0)4 72 18 20 00

Manitowoc - Asia Pacific

Shanghai, China

Tel: +86 21 6457 0066

Fax: +86 21 6457 4955

Regional offices

Americas

Brazil

Alphaville

Mexico

Monterrey

Chile

Santiago

Europe, Middle East & Africa

Czech Republic

Netvorice

France

Baudemont

Cergy

Decines

Germany

Langenfeld

Hungary

Budapest

Italy

Parabiago

Netherlands

Breda

Poland

Warsaw

Portugal

Baltar

Russia

Moscow

U.A.E.

Dubai

U.K.

Gawcott

Asia - Pacific

Australia

Brisbane

Melbourne

Sydney

China

Beijing

Xi'an

India

Hyderabad

Pune

Korea

Seoul

Philippines

Makati City

Singapore

Factories

Brazil

Alphaville

China

TaiAn

Zhangjiagang

France

Charlieu

La Clayette

Moulins

Germany

Wilhelmshaven

India

Pune

Italy

Niella Tanaro

Portugal

Baltar

Fânzeres

Slovakia

Saris

USA

Manitowoc

Port Washington

Shady Grove

This document is non-contractual. Constant improvement and engineering progress make it necessary that we reserve the right to make specification, equipment, and price changes without notice. Illustrations shown may include optional equipment and accessories and may not include all standard equipment.